

דגם A

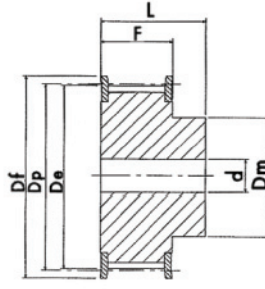

דגם B

9 מ"מ רוחב
15 מ"מ רוחב

מספר שיניים T	מק"ט		מידות [מ"מ]							דגם
	3M	3MR	Dp	De	Df	Dm	F	L	d	
10	GT10-3M-09-HTD	GT10-3MR-09	9.55	8.79	13	13	10.2	17.5	-	A
	GT10-3M-15-HTD	GT10-3MR-15	9.55	8.79	13	13	17	26	-	A
12	GT12-3M-09-HTD	GT12-3MR-09	11.46	10.70	15	15	10.2	17.5	-	A
	GT12-3M-15-HTD	GT12-3MR-15	11.46	10.70	15	15	17	26	-	A
14	GT14-3M-09-HTD	GT14-3MR-09	13.37	12.61	16	16	10.2	17.5	-	A
	GT14-3M-15-HTD	GT14-3MR-15	13.37	12.61	16	16	17	26	-	A
15	GT15-3M-09-HTD	GT15-3MR-09	14.32	13.56	17.5	17.5	10.2	17.5	-	A
	GT15-3M-15-HTD	GT15-3MR-15	14.32	13.56	17.5	17.5	17	26	-	A
16	GT16-3M-09-HTD	GT16-3MR-09	15.28	14.52	17.5	10	12.8	20.6	4	B
	GT16-3M-15-HTD	GT16-3MR-15	15.28	14.52	17.5	10	19.5	26	4	B
18	GT18-3M-09-HTD	GT18-3MR-09	17.19	16.43	20	11	12.8	20.6	6	B
	GT18-3M-15-HTD	GT18-3MR-15	17.19	16.43	20	11	19.5	26	6	B
20	GT20-3M-09-HTD	GT20-3MR-09	19.10	18.34	23	13	12.8	20.6	6	B
	GT20-3M-15-HTD	GT20-3MR-15	19.10	18.34	23	13	19.5	26	6	B
21	GT21-3M-09-HTD	GT21-3MR-09	20.05	19.29	25	14	12.8	20.6	6	B
	GT21-3M-15-HTD	GT21-3MR-15	20.05	19.29	25	14	19.5	26	6	B
22	GT22-3M-09-HTD	GT22-3MR-09	21.01	20.25	25	14	12.8	20.6	6	B
	GT22-3M-15-HTD	GT22-3MR-15	21.01	20.25	25	14	19.5	26	6	B
24	GT24-3M-09-HTD	GT24-3MR-09	22.92	22.16	25	14	12.8	20.6	6	B
	GT24-3M-15-HTD	GT24-3MR-15	22.92	22.16	25	14	19.5	26	6	B
26	GT26-3M-09-HTD	GT26-3MR-09	24.83	24.07	28	16	12.8	20.6	6	B
	GT26-3M-15-HTD	GT26-3MR-15	24.83	24.07	28	16	19.5	26	6	B
28	GT28-3M-09-HTD	GT28-3MR-09	26.74	25.98	32	18	12.8	20.6	6	B
	GT28-3M-15-HTD	GT28-3MR-15	26.74	25.98	32	18	19.5	26	6	B
30	GT30-3M-09-HTD	GT30-3MR-09	28.65	27.89	32	20	12.8	20.6	6	B
	GT30-3M-15-HTD	GT30-3MR-15	28.65	27.89	32	20	19.5	26	6	B
32	GT32-3M-09-HTD	GT32-3MR-09	30.56	29.80	36	22	12.8	20.6	6	B
	GT32-3M-15-HTD	GT32-3MR-15	30.56	29.80	36	22	19.5	26	6	B
36	GT36-3M-09-HTD	GT36-3MR-09	34.38	33.62	39	26	13.4	22.2	6	B
	GT36-3M-15-HTD	GT36-3MR-15	34.38	33.62	39	26	20	30	6	B
40	GT40-3M-09-HTD	GT40-3MR-09	38.20	37.44	42	28	13.4	22.2	6	B
	GT40-3M-15-HTD	GT40-3MR-15	38.20	37.44	42	28	20	30	6	B
44	GT44-3M-09-HTD	GT44-3MR-09	42.02	41.26	48	33	13.4	22.2	6	B
	GT44-3M-15-HTD	GT44-3MR-15	42.02	41.26	48	33	20	30	6	B

חומר אלומיניום

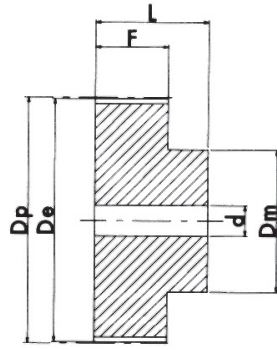
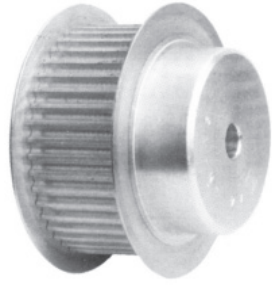

8 דגם

9 מ"מ רוחב
15 מ"מ רוחב

מספר שיניים	מק"ט		מידות [מ"מ]								דגם
	3M	3MR	Dp	De	Df	Dm	F	L	d		
48	GT48-3M-09-HTD	GT48-3MR-09	45.84	45.08	-	33	13.4	22.2	8	8	
	GT48-3M-15-HTD	GT48-3MR-15	45.84	45.08	-	33	20	30	8	8	
60	GT60-3M-09-HTD	GT60-3MR-09	57.30	56.54	-	33	13.4	22.2	8	8	
	GT60-3M-15-HTD	GT60-3MR-15	57.30	56.54	-	33	20	30	8	8	
72	GT72-3M-09-HTD	GT72-3MR-09	68.75	67.99	-	33	13.4	22.2	8	8	
	GT72-3M-15-HTD	GT72-3MR-15	68.75	67.99	-	33	20	30	8	8	

חומר אלומיניום

גלגלי תיזמון גי-גירום

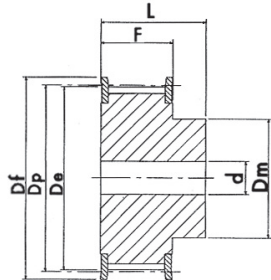
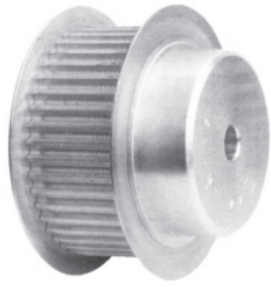

דגם B

9 מ"מ רוחב
15 מ"מ רוחב
25 מ"מ רוחב

מספר שיניים T	מק"ט		מידות [מ"מ]							דגם
	5M	5MR	Dp	De	Df	Dm	F	L	d	
12	GT12-5M-09-HTD	GT12-5MR-09	19.10	17.96	23	13	14.5	20	4	B
	GT12-5M-15-HTD	GT12-5MR-15	19.10	17.96	23	13	20.5	26	-	B
	GT12-5M-25-HTD	GT12-5MR-25	19.10	17.96	23	13	30.5	36	-	B
14	GT14-5M-09-HTD	GT14-5MR-09	22.28	21.14	25	13	14.5	20	6	B
	GT14-5M-15-HTD	GT14-5MR-15	22.28	21.14	25	13	20.5	26	6	B
	GT14-5M-25-HTD	GT14-5MR-25	22.28	21.14	25	13	30.5	36	6	B
15	GT15-5M-09-HTD	GT15-5MR-09	23.87	22.73	28	16	14.5	20	6	B
	GT15-5M-15-HTD	GT15-5MR-15	23.87	22.73	28	16	20.5	26	6	B
	GT15-5M-25-HTD	GT15-5MR-25	23.87	22.73	28	16	30.5	36	6	B
16	GT16-5M-09-HTD	GT16-5MR-09	25.46	24.32	28	16.5	14.5	20	6	B
	GT16-5M-15-HTD	GT16-5MR-15	25.46	24.32	28	16.5	20.5	26	6	B
	GT16-5M-25-HTD	GT16-5MR-25	25.46	24.32	28	16.5	30.5	36	6	B
18	GT18-5M-09-HTD	GT18-5MR-09	28.65	27.51	32	20	14.5	20	6	B
	GT18-5M-15-HTD	GT18-5MR-15	28.65	27.51	32	20	20.5	26	6	B
	GT18-5M-25-HTD	GT18-5MR-25	28.65	27.51	32	20	30.5	36	6	B
20	GT20-5M-09-HTD	GT20-5MR-09	31.83	30.69	36	23	14.5	22.5	6	B
	GT20-5M-15-HTD	GT20-5MR-15	31.83	30.69	36	23	20.5	26	6	B
	GT20-5M-25-HTD	GT20-5MR-25	31.83	30.69	36	23	30.5	36	6	B
21	GT21-5M-09-HTD	GT21-5MR-09	33.42	32.28	38	24	14.5	22.5	6	B
	GT21-5M-15-HTD	GT21-5MR-15	33.42	32.28	38	24	20.5	26	6	B
	GT21-5M-25-HTD	GT21-5MR-25	33.42	32.28	38	24	30.5	38	6	B
22	GT22-5M-09-HTD	GT22-5MR-09	35.01	33.87	39	25.5	14.5	22.5	6	B
	GT22-5M-15-HTD	GT22-5MR-15	35.01	33.87	39	25.5	20.5	26	6	B
	GT22-5M-25-HTD	GT22-5MR-25	35.01	33.87	39	25.5	30.5	38	6	B
24	GT24-5M-09-HTD	GT24-5MR-09	38.20	37.06	42	27	14.5	22.5	6	B
	GT24-5M-15-HTD	GT24-5MR-15	38.20	37.06	42	27	20.5	28	6	B
	GT24-5M-25-HTD	GT24-5MR-25	38.20	37.06	42	27	30.5	38	6	B
26	GT26-5M-09-HTD	GT26-5MR-09	41.38	40.24	44	30	14.5	22.5	6	B
	GT26-5M-15-HTD	GT26-5MR-15	41.38	40.24	44	30	20.5	28	6	B
	GT26-5M-25-HTD	GT26-5MR-25	41.38	40.24	44	30	30.5	38	6	B
28	GT28-5M-09-HTD	GT28-5MR-09	44.56	43.42	48	30.5	14.5	22.5	6	B
	GT28-5M-15-HTD	GT28-5MR-15	44.56	43.42	48	30.5	20.5	28	6	B
	GT28-5M-25-HTD	GT28-5MR-25	44.56	43.42	48	30.5	30.5	38	6	B
30	GT30-5M-09-HTD	GT30-5MR-09	47.75	46.60	51	35	14.5	22.5	6	B
	GT30-5M-15-HTD	GT30-5MR-15	47.75	46.60	51	35	20.5	28	6	B
	GT30-5M-25-HTD	GT30-5MR-25	47.75	46.60	51	35	30.5	38	6	B
32	GT32-5M-09-HTD	GT32-5MR-09	50.93	49.79	54	38	14.5	22.5	8	B
	GT32-5M-15-HTD	GT32-5MR-15	50.93	49.79	54	38	20.5	28	8	B
	GT32-5M-25-HTD	GT32-5MR-25	50.93	49.79	54	38	30.5	38	8	B

חומר ברזל

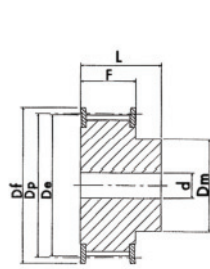
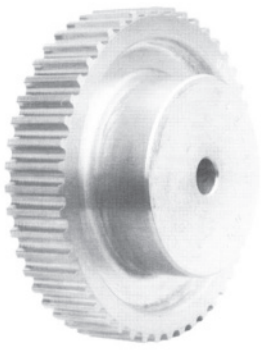

דגם B

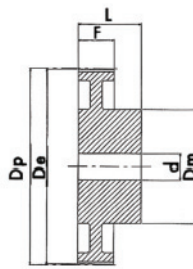

דגם D

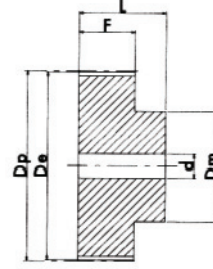

דגם 8

9 מ"מ רוחב
15 מ"מ רוחב
25 מ"מ רוחב

מספר שיניים	מק"ט		מידות [מ"מ]							דגם
	5M	5MR	Dp	De	Df	Dm	F	L	d	
36	GT36-5M-09-HTD	GT36-5MR-09	57.30	56.16	60	38	14.5	22.5	8	B
	GT36-5M-15-HTD	GT36-5MR-15	57.30	56.16	60	38	20.5	28	8	B
	GT36-5M-25-HTD	GT36-5MR-25	57.30	56.16	60	38	30.5	38	8	B
40	GT40-5M-09-HTD	GT40-5MR-09	63.66	62.52	71	38	14.5	22.5	8	B
	GT40-5M-15-HTD	GT40-5MR-15	63.66	62.52	71	38	20.5	28	8	B
	GT40-5M-25-HTD	GT40-5MR-25	63.66	62.52	71	38	30.5	38	8	B
44	GT44-5M-09-HTD	GT44-5MR-09	70.03	68.89	-	38	14.5	25.5	8	D
	GT44-5M-15-HTD	GT44-5MR-15	70.03	68.89	-	38	20.5	30	8	D
	GT44-5M-25-HTD	GT44-5MR-25	70.03	68.89	-	38	30.5	40	8	8
48	GT48-5M-09-HTD	GT48-5MR-09	76.39	75.25	-	45	14.5	25.5	8	D
	GT48-5M-15-HTD	GT48-5MR-15	76.39	75.25	-	38	20.5	30	8	D
	GT48-5M-25-HTD	GT48-5MR-25	76.39	75.25	-	38	30.5	40	8	D
60	GT60-5M-09-HTD	GT60-5MR-09	95.49	94.35	-	45	14.5	25.5	8	D
	GT60-5M-15-HTD	GT60-5MR-15	95.49	94.35	-	50	20.5	30	8	D
	GT60-5M-25-HTD	GT60-5MR-25	95.49	94.35	-	50	30.5	40	8	D
72	GT72-5M-09-HTD	GT72-5MR-09	114.59	113.45	-	45	14.5	25.5	8	D
	GT72-5M-15-HTD	GT72-5MR-15	114.59	113.45	-	50	20.5	30	8	D
	GT72-5M-25-HTD	GT72-5MR-25	114.59	113.45	-	50	30.5	40	8	D

חומר ברזל עד T=40
חומר אלומיניום החל מ-T=44

20 מ"מ רוחב
30 מ"מ רוחב
50 מ"מ רוחב
85 מ"מ רוחב

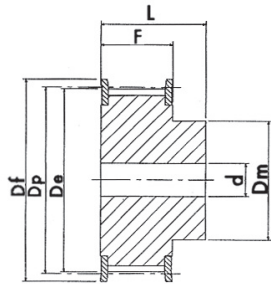

דגם B

מספר שיניים T	מק"ט 8M	מידות [מ"מ]								דגם
		Dp	De	Df	Dm	F	L	d		
22	GT22-8M-20-HTD	56.02	54.65	60	43	-	28	38	12	B
	GT22-8M-30-HTD	56.02	54.65	60	43	-	38	48	12	B
	GT22-8M-50-HTD	56.02	54.65	60	43	-	60	70	-	B
	GT22-8M-85-HTD	56.02	54.65	60	43	-	95	105	-	B
24	GT24-8M-20-HTD	61.12	59.75	66	45	-	28	38	12	B
	GT24-8M-30-HTD	61.12	59.75	66	45	-	38	48	12	B
	GT24-8M-50-HTD	61.12	59.75	66	45	-	60	70	-	B
	GT24-8M-85-HTD	61.12	59.75	66	45	-	95	105	-	B
26	GT26-8M-20-HTD	66.21	64.85	70	48	-	28	38	12	B
	GT26-8M-30-HTD	66.21	64.85	70	48	-	38	48	12	B
	GT26-8M-50-HTD	66.21	64.85	70	48	-	60	70	-	B
	GT26-8M-85-HTD	66.21	64.85	70	48	-	95	105	-	B
28	GT28-8M-20-HTD	71.30	70.08	75	50	-	28	38	15	B
	GT28-8M-30-HTD	71.30	70.08	75	50	-	38	48	15	B
	GT28-8M-50-HTD	71.30	70.08	75	50	-	60	70	-	B
	GT28-8M-85-HTD	71.30	70.08	75	50	-	95	105	-	B
30	GT30-8M-20-HTD	76.39	75.13	82.5	55	-	28	38	15	B
	GT30-8M-30-HTD	76.39	75.13	82.5	55	-	38	48	15	B
	GT30-8M-50-HTD	76.39	75.13	82.5	55	-	60	70	-	B
	GT30-8M-85-HTD	76.39	75.13	82.5	55	-	95	105	-	B
32	GT32-8M-20-HTD	81.49	80.16	87	60	-	28	38	15	B
	GT32-8M-30-HTD	81.49	80.16	87	60	-	38	48	15	B
	GT32-8M-50-HTD	81.49	80.16	87	60	-	60	70	-	B
	GT32-8M-85-HTD	81.49	80.16	87	60	-	95	105	-	B
34	GT34-8M-20-HTD	86.58	85.22	91	66	-	28	38	15	B
	GT34-8M-30-HTD	86.58	85.22	91	66	-	38	48	15	B
	GT34-8M-50-HTD	86.58	85.22	91	66	-	60	70	-	B
	GT34-8M-85-HTD	86.58	85.22	91	66	-	95	105	-	B
36	GT36-8M-20-HTD	91.67	90.30	97	70	-	28	38	15	B
	GT36-8M-30-HTD	91.67	90.30	97	70	-	38	48	15	B
	GT36-8M-50-HTD	91.67	90.30	97	70	-	60	70	-	B
	GT36-8M-85-HTD	91.67	90.30	97	70	-	95	105	-	B
38	GT38-8M-20-HTD	96.77	95.39	102	75	-	28	38	15	B
	GT38-8M-30-HTD	96.77	95.39	102	75	-	38	48	15	B
	GT38-8M-50-HTD	96.77	95.39	102	75	-	60	70	-	B
	GT38-8M-85-HTD	96.77	95.39	102	75	-	95	105	-	B
40	GT40-8M-20-HTD	101.86	100.49	106	75	-	28	38	15	B
	GT40-8M-30-HTD	101.86	100.49	106	75	-	38	48	15	B
	GT40-8M-50-HTD	101.86	100.49	106	75	-	60	70	-	B
	GT40-8M-85-HTD	101.86	100.49	106	75	-	95	105	-	B
44	GT44-8M-20-HTD	112.05	110.67	120	75	-	28	38	15	B
	GT44-8M-30-HTD	112.05	110.67	120	75	-	38	48	15	B
	GT44-8M-50-HTD	112.05	110.67	120	75	-	60	70	-	B
	GT44-8M-85-HTD	112.05	110.67	120	75	-	95	105	-	B

חומר ברזל

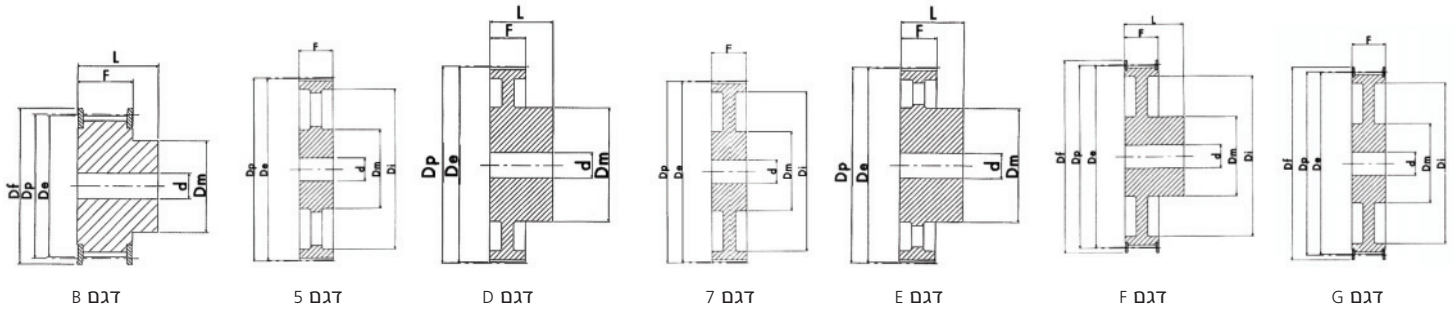

מספר שיניים T	מק"ט 8M	מידות [מ"מ]								דגם
		Dp	De	Df	Dm	Di	F	L	d	
48	GT48-8M-20-HTD	122.23	120.86	128	75	-	28	38	15	B
	GT48-8M-30-HTD	122.23	120.86	128	75	-	38	48	15	B
	GT48-8M-50-HTD	122.23	120.86	128	80	-	60	70	-	B
	GT48-8M-85-HTD	122.23	120.86	128	80	-	95	105	-	B
56	GT56-8M-20-HTD	142.60	141.23	150	80	116	28	38	15	F
	GT56-8M-30-HTD	142.60	141.23	150	90	116	38	48	15	F
	GT56-8M-50-HTD	142.60	141.23	150	90	116	60	60	18	G
	GT56-8M-85-HTD	142.60	141.23	150	80	-	95	105	20	B
64	GT64-8M-20-HTD	162.97	161.60	168	80	137	28	38	15	F
	GT64-8M-30-HTD	162.97	161.60	168	90	137	38	48	15	F
	GT64-8M-50-HTD	162.97	161.60	168	100	137	60	60	18	G
	GT64-8M-85-HTD	162.97	161.60	168	100	137	95	95	20	G
72	GT72-8M-20-HTD	183.35	181.97	192	80	158	28	38	15	F
	GT72-8M-30-HTD	183.35	181.97	192	95	158	38	48	15	F
	GT72-8M-50-HTD	183.35	181.97	192	100	158	60	60	18	G
	GT72-8M-85-HTD	183.35	181.97	192	110	158	95	95	20	G
80	GT80-8M-20-HTD	203.72	202.35	-	90	180	28	38	15	D
	GT80-8M-30-HTD	203.72	202.35	-	100	180	38	48	15	D
	GT80-8M-50-HTD	203.72	202.35	-	110	180	60	60	18	7
	GT80-8M-85-HTD	203.72	202.35	-	110	180	95	95	20	5
90	GT90-8M-20-HTD	229.18	227.81	-	90	204	28	38	15	D
	GT90-8M-30-HTD	229.18	227.81	-	100	204	38	48	15	D
	GT90-8M-50-HTD	229.18	227.81	-	110	204	60	60	18	7
	GT90-8M-85-HTD	229.18	227.81	-	110	204	95	95	20	5
112	GT112-8M-20-HTD	285.21	283.83	-	90	254	28	38	18	E
	GT112-8M-30-HTD	285.21	283.83	-	100	254	38	48	18	E
	GT112-8M-50-HTD	285.21	283.83	-	110	254	60	60	18	5
	GT112-8M-85-HTD	285.21	283.83	-	110	254	95	95	24	5
144	GT144-8M-20-HTD	366.69	365.32	-	90	336	28	38	20	E
	GT144-8M-30-HTD	366.69	365.32	-	100	336	38	48	20	E
	GT144-8M-50-HTD	366.69	365.32	-	110	336	60	60	20	5
	GT144-8M-85-HTD	366.69	365.32	-	120	336	95	95	24	5
168	GT168-8M-20-HTD	427.81	426.44	-	100	400	28	38	20	E
	GT168-8M-30-HTD	427.81	426.44	-	100	400	38	48	20	E
	GT168-8M-50-HTD	427.81	426.44	-	120	400	60	60	20	5
	GT168-8M-85-HTD	427.81	426.44	-	120	400	95	95	24	5
192	GT192-8M-20-HTD	488.92	487.55	-	100	460	28	38	20	E
	GT192-8M-30-HTD	488.92	487.55	-	100	460	38	48	20	E
	GT192-8M-50-HTD	488.92	487.55	-	130	460	60	60	20	5
	GT192-8M-85-HTD	488.92	487.55	-	130	460	95	95	24	5

חומר ברזל עד T=72
חומר יציקה החל מ-T=80

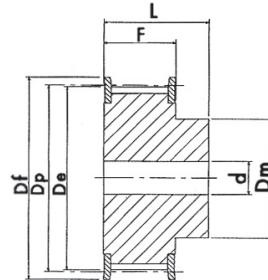
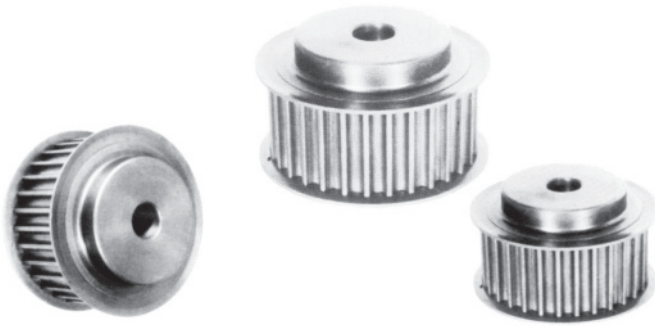

דגם B

- 40 מ"מ רחב
- 55 מ"מ רחב
- 85 מ"מ רחב
- 115 מ"מ רחב
- 170 מ"מ רחב

מספר שיניים	מק"ט	מידות [מ"מ]								דגם
		T	14M	Dp	De	Df	Dm	Di	F	
28	GT28-14M-40-HTD	124.78	122.12	128	100	-	54	69	24	B
	GT28-14M-55-HTD	124.78	122.12	128	100	-	70	85	24	B
	GT28-14M-85-HTD	124.78	122.12	128	100	-	102	117	-	B
	GT28-14M-115-HTD	124.78	122.12	128	100	-	133	148	-	B
	GT28-14M-170-HTD	124.78	122.12	128	100	-	187	202	-	B
29	GT29-14M-40-HTD	129.23	126.57	138	100	-	54	69	24	B
	GT29-14M-55-HTD	129.23	126.57	138	100	-	70	85	24	B
	GT29-14M-85-HTD	129.23	126.57	138	100	-	102	117	-	B
	GT29-14M-115-HTD	129.23	126.57	138	100	-	133	148	-	B
	GT29-14M-170-HTD	129.23	126.57	138	100	-	187	202	-	B
30	GT30-14M-40-HTD	133.69	130.99	138	100	-	54	69	24	B
	GT30-14M-55-HTD	133.69	130.99	138	100	-	70	85	24	B
	GT30-14M-85-HTD	133.69	130.99	138	100	-	102	117	-	B
	GT30-14M-115-HTD	133.69	130.99	138	100	-	133	148	-	B
	GT30-14M-170-HTD	133.69	130.99	138	100	-	187	202	-	B
32	GT32-14M-40-HTD	142.60	139.88	154	100	-	54	69	24	B
	GT32-14M-55-HTD	142.60	139.88	154	100	-	70	85	24	B
	GT32-14M-85-HTD	142.60	139.88	154	100	-	102	117	-	B
	GT32-14M-115-HTD	142.60	139.88	154	100	-	133	148	-	B
	GT32-14M-170-HTD	142.60	139.88	154	100	-	187	202	-	B
34	GT34-14M-40-HTD	151.52	148.79	160	100	-	54	69	24	B
	GT34-14M-55-HTD	151.52	148.79	160	100	-	70	85	24	B
	GT34-14M-85-HTD	151.52	148.79	160	100	-	102	117	-	B
	GT34-14M-115-HTD	151.52	148.79	160	100	-	133	148	-	B
	GT34-14M-170-HTD	151.52	148.79	160	100	-	187	202	-	B
36	GT36-14M-40-HTD	160.43	157.68	168	100	-	54	69	24	B
	GT36-14M-55-HTD	160.43	157.68	168	100	-	70	85	24	B
	GT36-14M-85-HTD	160.43	157.68	168	100	-	102	117	-	B
	GT36-14M-115-HTD	160.43	157.68	168	120	-	133	148	-	B
	GT36-14M-170-HTD	160.43	157.68	168	120	-	187	202	-	B
38	GT38-14M-40-HTD	169.34	166.60	183	120	-	54	69	24	B
	GT38-14M-55-HTD	169.34	166.60	183	120	-	70	85	24	B
	GT38-14M-85-HTD	169.34	166.60	183	120	-	102	117	-	B
	GT38-14M-115-HTD	169.34	166.60	183	120	-	133	148	-	B
	GT38-14M-170-HTD	169.34	166.60	183	135	-	187	202	-	B
40	GT40-14M-40-HTD	178.25	175.49	188	120	-	54	69	24	B
	GT40-14M-55-HTD	178.25	175.49	188	120	-	70	85	24	B
	GT40-14M-85-HTD	178.25	175.49	188	135	-	102	117	-	B
	GT40-14M-115-HTD	178.25	175.49	188	135	-	133	148	-	B
	GT40-14M-170-HTD	178.25	175.49	188	140	-	187	202	-	B
44	GT44-14M-40-HTD	196.08	193.28	211	120	-	54	69	24	B
	GT44-14M-55-HTD	196.08	193.28	211	135	-	70	85	24	B
	GT44-14M-85-HTD	196.08	193.28	211	135	-	102	117	-	B
	GT44-14M-115-HTD	196.08	193.28	211	140	-	133	148	-	B
	GT44-14M-170-HTD	196.08	193.28	211	160	-	187	202	-	B

40 מ"מ רוחב
55 מ"מ רוחב
85 מ"מ רוחב
115 מ"מ רוחב
170 מ"מ רוחב

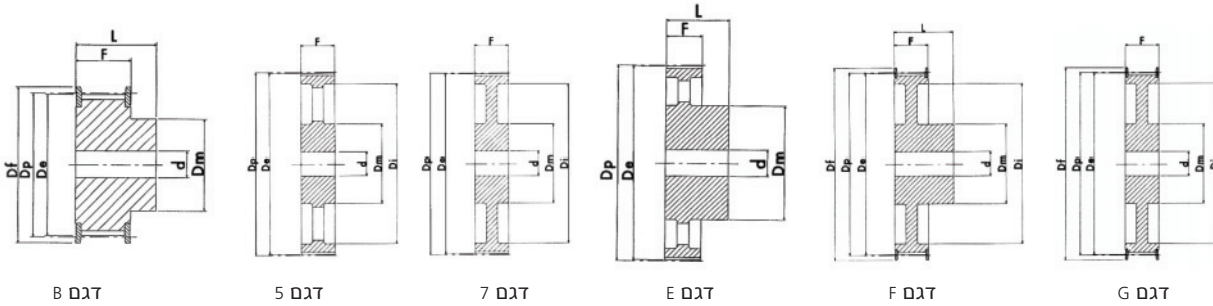

מספר שיניים T	מק"ט 14M	מידות [מ"מ]								דגם
		Dp	De	Df	Dm	Di	F	L	d	
48	GT48-14M-40-HTD	213.90	211.11	226	135	170	54	69	24	F
	GT48-14M-55-HTD	213.90	211.11	226	135	170	70	70	24	G
	GT48-14M-85-HTD	213.90	211.11	226	150	-	102	117	-	B
	GT48-14M-115-HTD	213.90	211.11	226	150	-	133	148	-	B
	GT48-14M-170-HTD	213.90	211.11	226	160	-	187	202	-	B
56	GT56-14M-40-HTD	249.55	246.76	256	135	207	54	69	28	F
	GT56-14M-55-HTD	249.55	246.76	256	135	207	70	70	28	G
	GT56-14M-85-HTD	249.55	246.76	256	150	207	102	102	32	G
	GT56-14M-115-HTD	249.55	246.76	256	150	-	133	148	-	B
	GT56-14M-170-HTD	249.55	246.76	256	160	-	187	202	-	B
64	GT64-14M-40-HTD	285.21	282.41	296	135	240	54	69	28	F
	GT64-14M-55-HTD	285.21	282.41	296	135	240	70	70	28	G
	GT64-14M-85-HTD	285.21	282.41	296	150	240	102	102	32	G
	GT64-14M-115-HTD	285.21	282.41	296	150	240	133	133	32	G
	GT64-14M-170-HTD	285.21	282.41	296	180	-	187	202	-	B
72	GT72-14M-40-HTD	320.86	318.06	-	135	278	54	69	28	E
	GT72-14M-55-HTD	320.86	318.06	-	135	278	70	70	28	5
	GT72-14M-85-HTD	320.86	318.06	-	150	278	102	102	32	5
	GT72-14M-115-HTD	320.86	318.06	-	150	278	133	133	32	5
	GT72-14M-170-HTD	320.86	318.06	-	180	278	187	187	32	7
80	GT80-14M-40-HTD	356.51	353.71	-	135	314	54	69	28	E
	GT80-14M-55-HTD	356.51	353.71	-	135	314	70	70	28	5
	GT80-14M-85-HTD	356.51	353.71	-	150	314	102	102	32	5
	GT80-14M-115-HTD	356.51	353.71	-	150	314	133	133	32	5
	GT80-14M-170-HTD	356.51	353.71	-	180	314	187	187	32	7
90	GT90-14M-40-HTD	401.07	398.28	-	135	358	54	69	28	E
	GT90-14M-55-HTD	401.07	398.28	-	135	358	70	70	28	5
	GT90-14M-85-HTD	401.07	398.28	-	150	358	102	102	32	5
	GT90-14M-115-HTD	401.07	398.28	-	150	358	133	133	32	5
	GT90-14M-170-HTD	401.07	398.28	-	180	358	187	187	38	5
112	GT112-14M-40-HTD	499.11	496.32	-	135	456	54	69	28	E
	GT112-14M-55-HTD	499.11	496.32	-	135	456	70	70	28	5
	GT112-14M-85-HTD	499.11	496.32	-	150	456	102	102	32	5
	GT112-14M-115-HTD	499.11	496.32	-	150	456	133	133	32	5
	GT112-14M-170-HTD	499.11	496.32	-	200	456	187	187	38	5
144	GT144-14M-40-HTD	641.71	638.92	-	135	600	54	69	28	E
	GT144-14M-55-HTD	641.71	638.92	-	135	600	70	70	28	5
	GT144-14M-85-HTD	641.71	638.92	-	135	600	102	102	32	5
	GT144-14M-115-HTD	641.71	638.92	-	165	600	133	133	32	5
	GT144-14M-170-HTD	641.71	638.92	-	220	600	187	187	38	5
168	GT168-14M-40-HTD	748.66	745.87	-	135	706	54	69	28	E
	GT168-14M-55-HTD	748.66	745.87	-	135	706	70	70	28	5
	GT168-14M-85-HTD	748.66	745.87	-	150	706	102	102	32	5
	GT168-14M-115-HTD	748.66	745.87	-	165	706	133	133	32	5
	GT168-14M-170-HTD	748.66	745.87	-	220	706	187	187	38	5